

AC 1555 SERIES AXIAL FAN (High Air Flow)

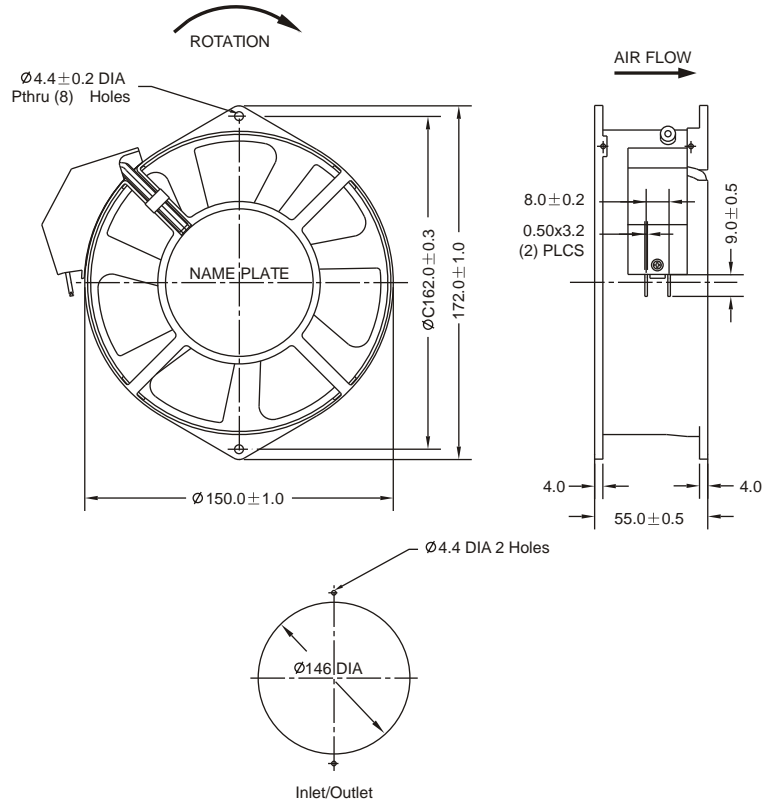

**Size:** 162mmx150mmx55mm  
**Airflow:** 425~498m<sup>3</sup>/hr  
 250~293CFM  
**Weight:** 870g  
**Noise:** 57~61dBA  
**Impeller:** PA6 UL94V-0 Reinforced Plastic  
**Frame:** Aluminum Alloy  
**Terminals:** 0.5mm  
**Lead Wire:** AWG#22 UL 1015  
 (Optional)  
**Motor:** Capacitor-Run Induction Motor  
**Safety:** UL.CUL.TUV.CE  
**Operation Temperature:** -10°C~+60°C

Unit:mm

Model	Bearing System	Voltage VAC	Freq. Hz	Current A	Power W	Speed RPM	Noise dBA	Air Flow		Static Pressure (mmH <sub>2</sub> O)	Weight Gram
								M <sup>3</sup> /hr	CFM		
RAH1555B1-C	Ball	220~240	50/60	0.20/0.22	46/50	2850/3300	56/61	425/498	250/293	16.0/20.0	870
RAH1555B2-C		100~125	50/60	0.35/0.40	46/50	2850/3300	56/61	425/498	250/293	16.0/20.0	

